

SCNS 035

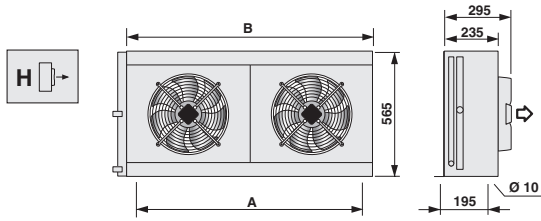

Mod.		A	B	C	D
035/1		600	740	590	740
035/2		1150	1295	1140	1295
035/3		1700	1845	1690	1845

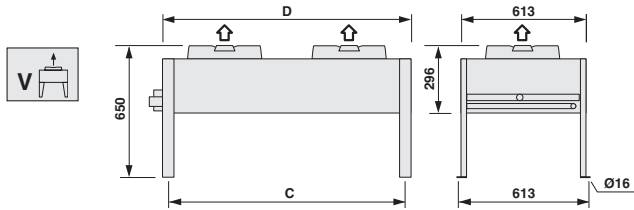

SCNS 050

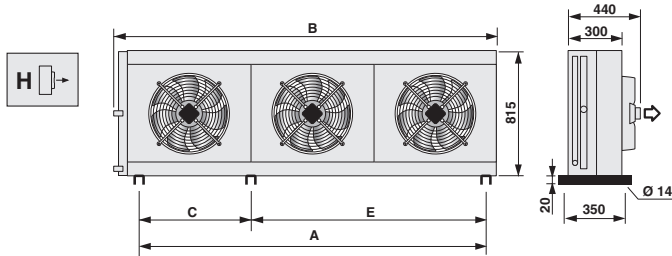

Mod.		A	B	C	D	E
050/1		850	1025	-	1025	-
050/2		1700	1875	-	1875	-
050/3		2550	2750	-	2725	-
050/4		3400	3575	1700	3575	1700

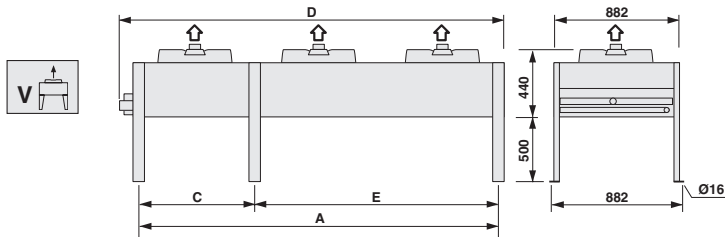

SCNL 050

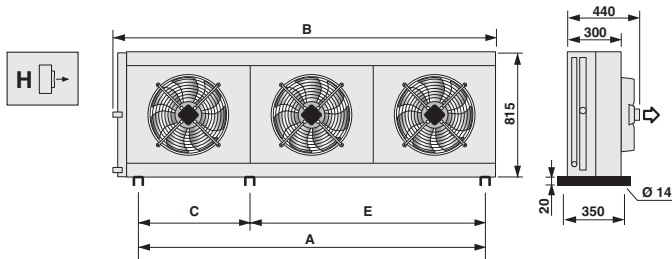

Mod.		A	B	C	D	E
050/1		1100	1275	-	1275	-
050/2		2200	2375	-	2375	-
050/3		3300	3475	-	3475	-
050/4		4400	4575	2200	4575	2200

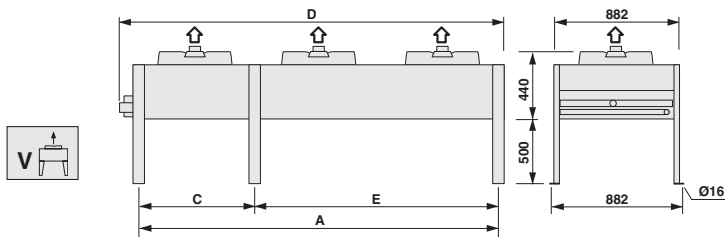

Flusso aria orizzontale
Horizontal flux
Horizontaler Luftstrom
Direction de l'air horizontal

Flusso aria verticale
Vertical flux
Vertikaler Luftstrom
Direction de l'air vertical

SCNS 063

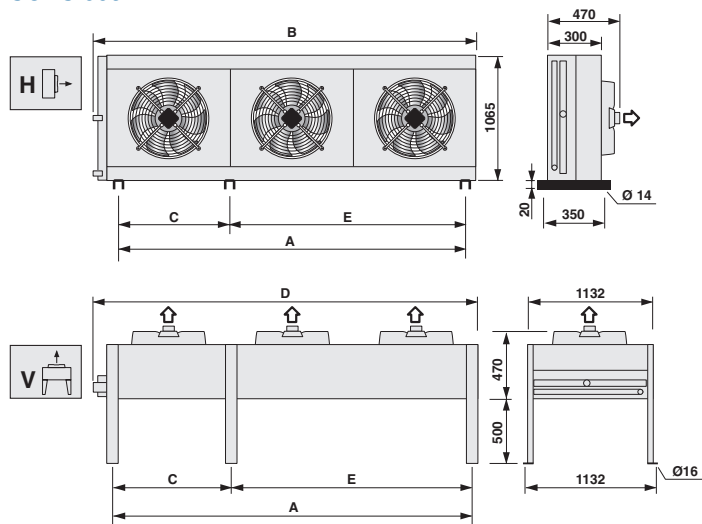

Mod.		A	B	C	D	E
063/1		1100	1275	-	1275	-
063/2		2200	2375	-	2375	-
063/3		3300	3475	-	3475	-
063/4		4400	4575	2200	4575	2200

SCNL 063

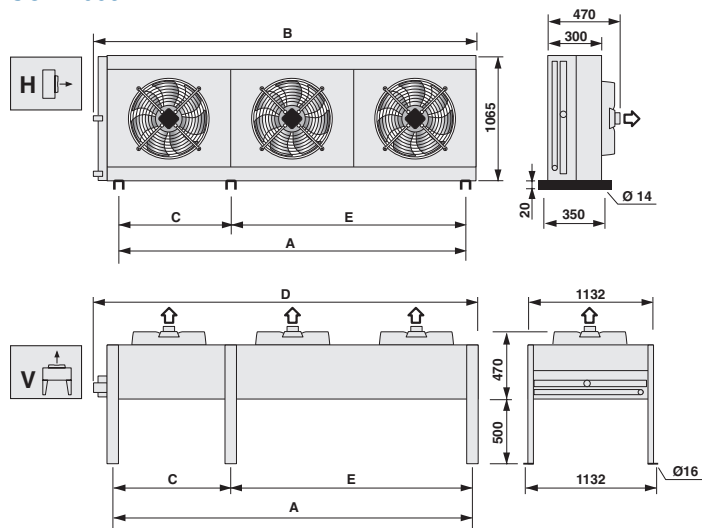

Mod.		A	B	C	D	E
063/1		1300	1475	-	1475	-
063/2		2600	2775	-	2775	-
063/3		3900	4075	-	4075	-
063/4		5200	5375	2600	5375	2600

SCS 080-090

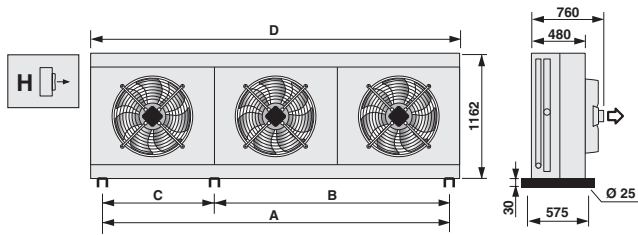

Mod.		A	B	C	D
080-090/2		3100	-	-	3400
080-090/3		4650	-	-	4950
080-090/4		6200	3100	3100	6500
080-090/5		7750	4650	3100	8050

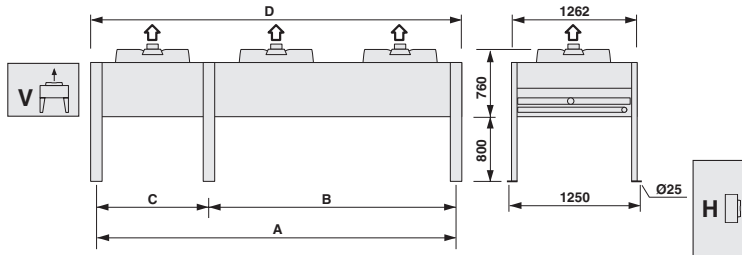

Flusso aria orizzontale
Horizontal flux
Horizontaler Luftstrom
Direction de l'air horizontal

Flusso aria verticale
Vertical flux
Vertikaler Luftstrom
Direction de l'air vertical

SCL 080-090

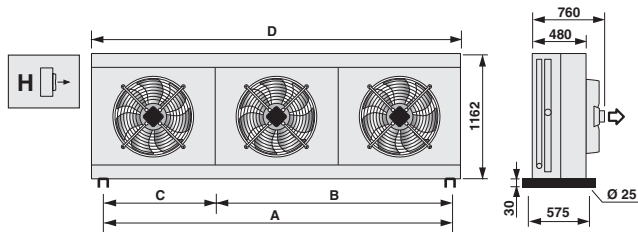

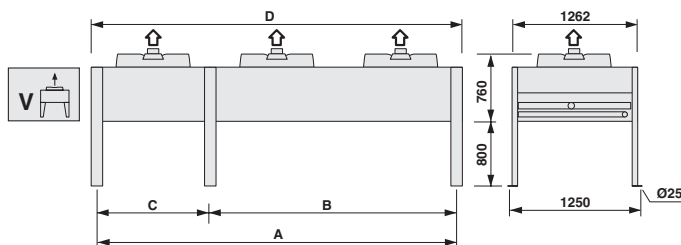

Mod.		A	B	C	D
080-090/2		3860	-	-	4160
080-090/3		5790	-	-	6090
080-090/4		7720	3860	3860	8020



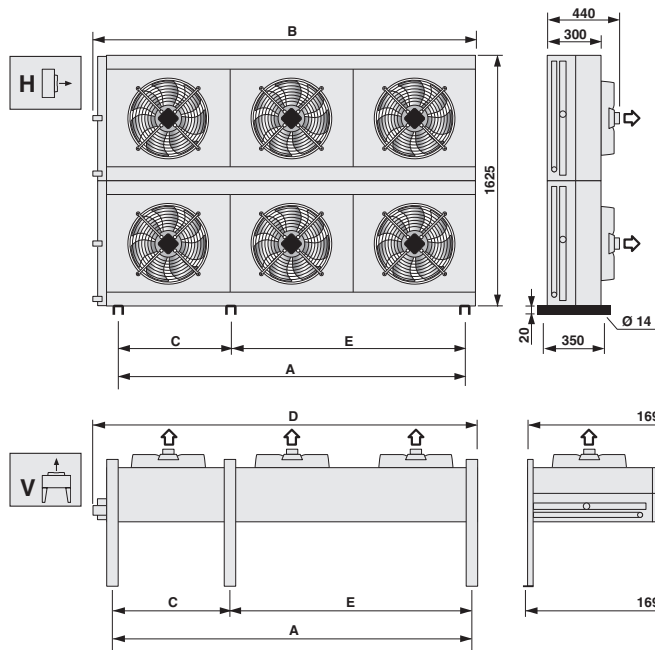

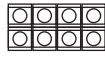

SCNS 050 DUAL



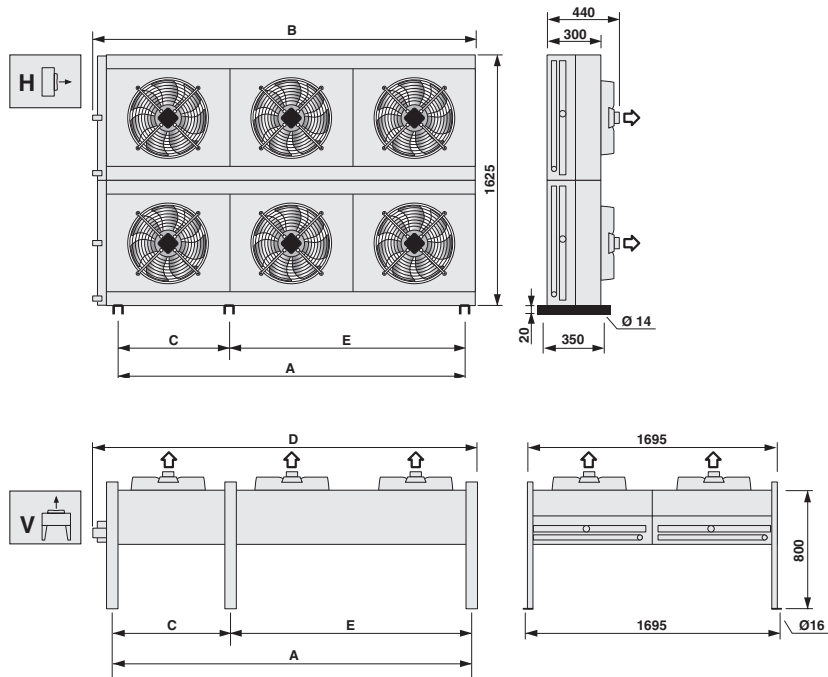

Mod.	A	B	C	D	E
050/2.2 	1700	1875	-	1875	-
050/3.2 	2550	2750	-	2750	-
050/4.2 	3400	3575	1700	3575	1700

SCNL 050 DUAL







Mod.	A	B	C	D	E
050/2.2 	2200	2375	-	2375	-
050/3.2 	3300	3475	-	3475	-
050/4.2 	4400	4575	2200	4575	2200

 Flusso aria orizzontale
 Horizontal flux
 Horizontaler Luftstrom
 Direction de l'air horizontal

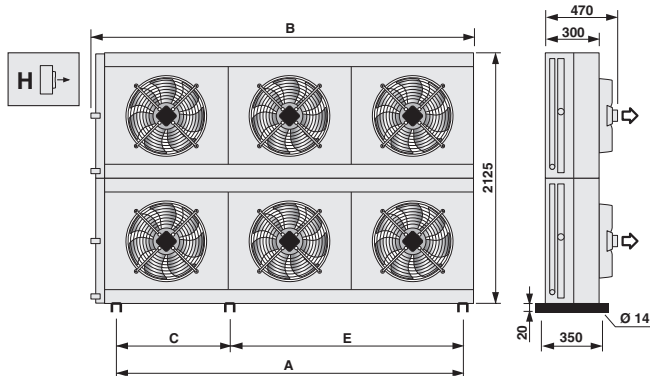
 Flusso aria verticale
 Vertical flux
 Vertikaler Luftstrom
 Direction de l'air vertical

SCNS 063 DUAL



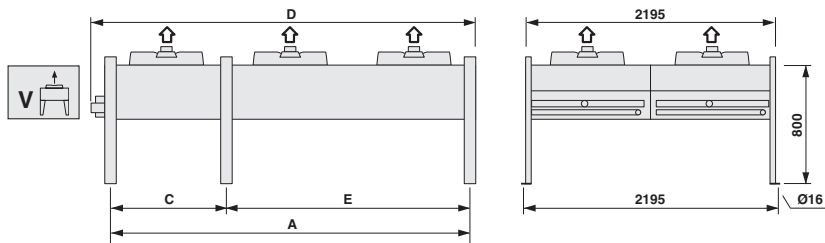

Mod.	A	B	C	D	E
063/2.2 	2200	2375	-	2375	-
063/3.2 	3300	3475	-	3475	-
063/4.2 	4400	4575	2200	4575	2200



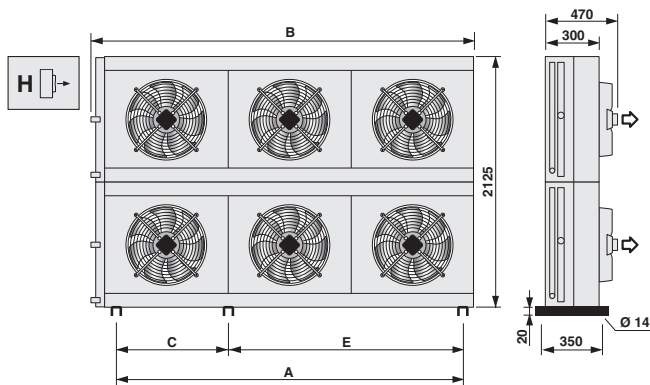

SCNL 063 DUAL

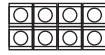

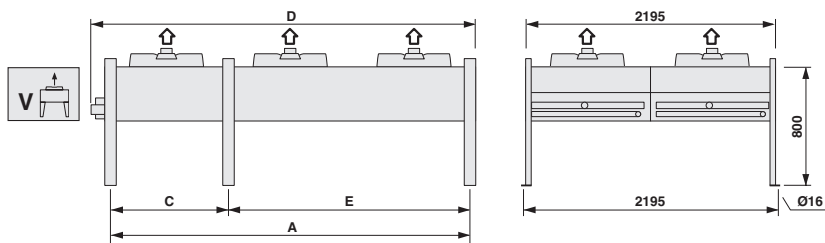
Mod.	A	B	C	D	E
063/2.2 	2600	2775	-	2775	-
063/3.2 	3900	4075	1300	4075	2600
063/4.2 	5200	5375	2600	5375	2600





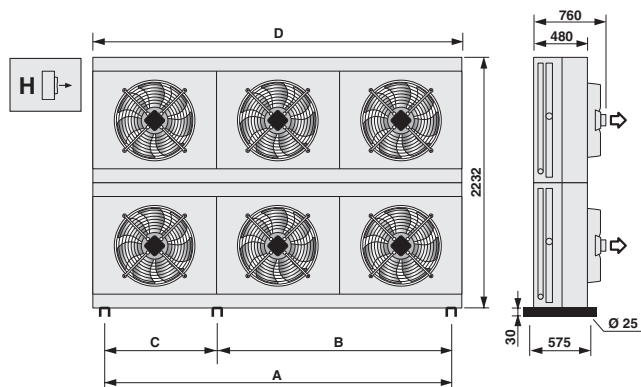

 Flusso aria orizzontale
 Horizontal flux
 Horizontaler Luftstrom
 Direction de l'air horizontal

 Flusso aria verticale
 Vertical flux
 Vertikaler Luftstrom
 Direction de l'air vertical

SCS 080-090 DUAL



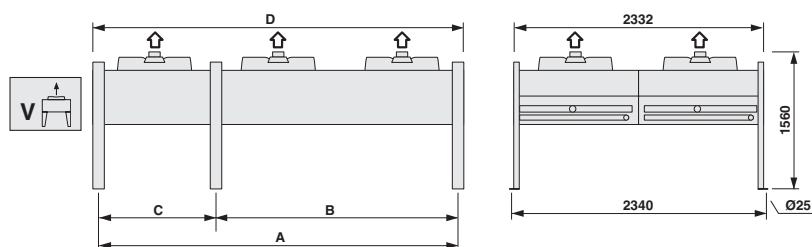

Mod.	A	B	C	D
080-090/2.2 	3100	-	-	3400
080-090/3.2 	4650	-	-	4950
080-090/4.2 	6200	3100	3100	6500
080-090/5.2 	7750	4650	3100	8050
080-090/6.2 	9300	4650	4650	9600

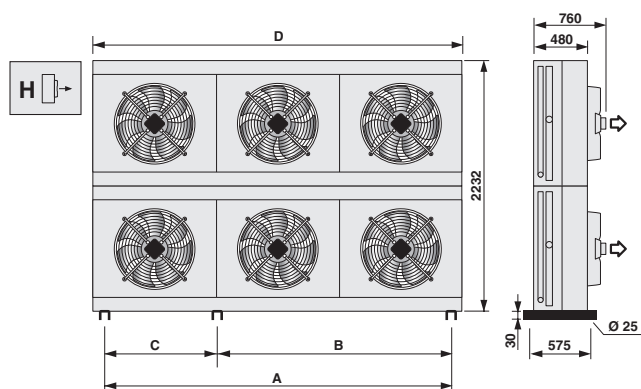

SCL 080-090 DUAL

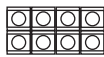

Mod.	A	B	C	D
080-090/2.2 	3860	-	-	4160
080-090/3.2 	5790	3860	1930	6090
080-090/4.2 	7720	3860	3860	8020
080-090/5.2 	9650	5790	3860	9950

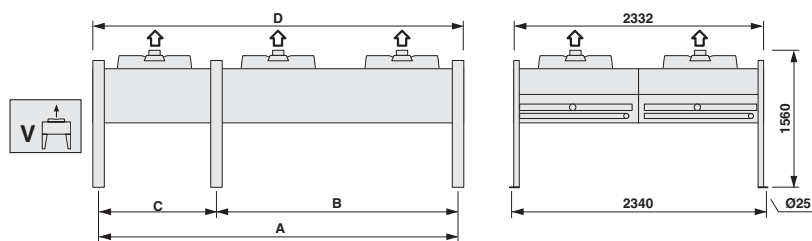

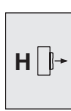
 Flusso aria orizzontale
 Horizontal flux
 Horizontaler Luftstrom
 Direction de l'air horizontal

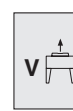
 Flusso aria verticale
 Vertical flux
 Vertikaler Luftstrom
 Direction de l'air vertical

SCV 080 - 090

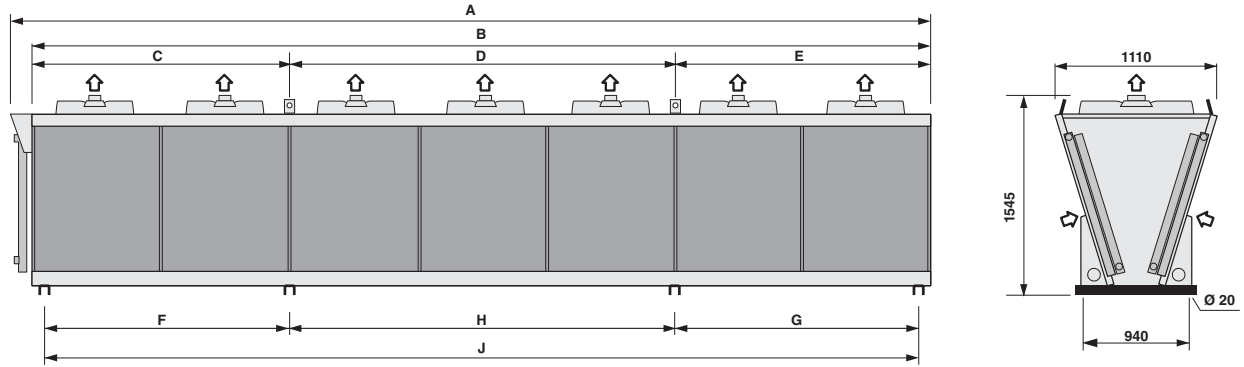

Mod.		A	B	C	D	E	F	G	H	J
080-090/1		1431	1110	-	1070	-	-	-	-	1070
080-090/2		2501	2180	-	2140	-	-	-	-	2140
080-090/3		3571	3250	-	3210	-	-	-	-	3210
080-090/4		4641	4320	1090	2140	1090	2140	2140	-	4280
080-090/5		5711	5390	1090	3210	1090	2140	2140	1070	5350
080-090/6		6781	6460	2160	2140	2160	2140	2140	2140	6420
080-090/7		7851	7530	2160	3210	2160	2140	2140	3210	7490

SCNV 080 - 090 DUAL

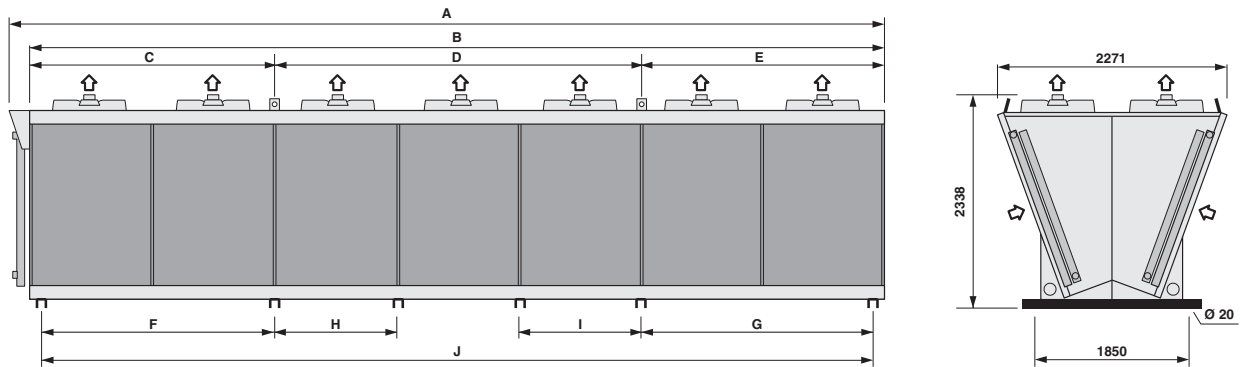

Mod.		A	B	C	D	E	F	G	H	I	J
080-090/2.2		2969	2544	-	-	-	-	2500	-	-	2500
080-090/3.2		4219	3794	1272	1250	1272	1250	2500	-	-	3750
080-090/4.2		5469	5044	1272	2500	1272	2500	2500	-	-	5000
080-090/5.2		6719	6294	1272	3750	1272	2500	2500	-	-	6250
080-090/6.2		7969	7544	2522	2500	2522	2500	2500	2500	-	7500
080-090/7.2		9219	8794	2522	3750	2522	2500	2500	1250	1250	8750
080-090/8.2		10469	10044	1272	2500	1272	2500	2500	2500	-	10000